

Vet BP



  
**SunTech**® *Vet25*<sup>™</sup>  
BP MONITOR



# Spot-Check and Continuous BP Monitor for Companion Animals

User Manual

## Changes

This manual is identified as part number: 80-0076-00-RevC. This manual is for use with Vet25 model M25. An updated version may be available for download from the SunTech Medical website. Should you notice errors or omissions in this manual, please notify us at:

SunTech Medical, Inc.

507 Airport Boulevard, Suite 117

Morrisville, NC 27560 USA

Tel: 800.421.8626

919.654.2300

Fax: 919.654.2301

Email: [CustomerService@SunTechMed.com](mailto:CustomerService@SunTechMed.com)

Web: [www.SunTechMed.com](http://www.SunTechMed.com)

## Copyright Information

All content in this manual is the proprietary information of SunTech Medical and is provided solely for purposes of operation of the SunTech Vet25. This manual and the Vet25 described in it are protected under copyright law under which they may not be copied, in whole or in part, without written consent of SunTech Medical.

The information in this manual is furnished for guidance only, is subject to change without notice, and should not be construed as a commitment by SunTech Medical. SunTech Medical assumes no liability for errors or inaccuracies that may appear in this manual.

© 2017 SunTech Medical. All rights reserved.



SunTech Medical, Inc.  
507 Airport Blvd, #117  
Morrisville, NC 27560-8200  
Phone: 1-919-654-2300  
1-800-421-8626  
Fax: 1-919-654-2301



SunTech Medical, Ltd.  
Oakfield Industrial Estate  
Stanton Harcourt Road  
Eynsham, Oxfordshire OX29 4TS  
England  
Phone: + 44 (0) 1865-884-234  
Fax: + 44 (0) 1865-884-235

Other office location:

SunTech Medical (Shenzhen) Co., Ltd.  
105 HuanGuan South Road, Suite 15 2~3/F  
DaHe Community Guanlan,  
LongHua District, Shenzhen  
GuangDong PRC 518110  
Tel: + 86-755-29588810  
+ 86-755-29588986 (Sales)  
+ 86-755-29588665 (Service)  
Fax: + 86-755-29588829

## Welcome to the SunTech Vet25

Thank you for choosing the Vet25 vital signs monitor! For over 30 years, SunTech Medical has been the preeminent supplier of leading edge technology and innovative products to obtain blood pressure (BP) measurements. Developed specifically for the veterinary care environment, the Vet25 can perform automatic BP measurements for veterinary professionals.

For measuring BP, a BP cuff is placed around the patient's forelimb or tail. The cuff is inflated automatically and blood pressure is determined by the oscillometric method, which senses pressure waves in the artery when occluded by pressure in the cuff. Measurement of the frequency of the pressure waves enables heart rate to also be measured.

The Vet25 is a portable device, weighing approximately 2.1 lb (952 g). Control buttons allow the user to turn on or off the device and stop/start a BP measurement. The touchscreen display shows the device status and measurement information, and allows for selection of settings. The device uses a microprocessor with software, which is not accessible to the user. The unit is powered by a single rechargeable lithium-ion battery at the bottom of the device. Bluetooth can be used to wirelessly connect and send data to a PC application, which may be downloaded from the SunTech website at: <https://www.suntechmed.com/vet25-data-capture>. Upper and lower alarm limits can be set for all parameters.

## Intended Use

The SunTech Vet25 and Vet30 monitors are clinical grade automated blood pressure measurement devices that provide oscillometric non-invasive blood pressure. The Vet30 provides additional pulse oximetry and temperature measurement capabilities. These portable devices are for use in the veterinary clinic on companion animals (cats and dogs). The devices can be used for spot-check or continuous monitoring activities. They are not intended for human use.

The devices are contraindicated for use on humans or any species other than those described above.

## Vet25 Essential Performance

The Essential Performance of the Vet25 is designed to measure, record, and display a patient's blood pressure within a blood pressure accuracy range of +/- 5 mmHg mean error & 8mm Hg standard deviation (*max inflate 280 mmHg*).

## User Responsibility

The Vet25 is designed to perform in conformity with the description thereof contained in this operation manual when operated. This operation manual is for use with Vet25 model M25. The user of this monitor shall have the sole responsibility for any malfunction which results from improper use, faulty maintenance, improper repair, damage or alteration by anyone other than SunTech Medical or their authorized service personnel. The Vet25 is for use only by or on the direction of a licensed veterinarian.

## Use of Vet25

Use only veterinary BP cuffs supplied by SunTech Medical. Observe the patient carefully during the measurement. Accuracy of any BP reading measurement may be affected by the position of the patient, their physical condition and use outside of the operating instructions detailed in this guide. The interpretation of BP measurements should only be made by a veterinarian.

# Table of Contents

|   |           |  |           |
|---|-----------|--|-----------|
| Changes.....                                    | 2         | 6.2 Averaging Measurements .....                 | 19        |
| Copyright Information .....                     | 2         | 6.3 Bluetooth Connection .....                   | 19        |
| Welcome to the SunTech Vet25 .....              | 3         | 6.4 Data Transfer .....                          | 20        |
| Intended Use .....                              | 3         | 6.5 Reviewing Data and Creating Reports.....     | 20        |
| <b>1. Warnings and Precautions .....</b>        | <b>5</b>  | <b>7. Alarms .....</b>                           | <b>22</b> |
| <b>2. Icons and Symbols .....</b>               | <b>6</b>  | 7.1 Technical Alarms .....                       | 22        |
| <b>3. Getting to Know SunTech Vet25.....</b>    | <b>8</b>  | 7.2 Clinical Alarms .....                        | 23        |
| 3.1 Applied Parts.....                          | 8         | <b>8. Taking Care of the SunTech Vet25 .....</b> | <b>23</b> |
| 3.2 Device Placement .....                      | 8         | 8.1 Battery .....                                | 23        |
| 3.3 Front Panel .....                           | 9         | 8.2 Cleaning.....                                | 23        |
| 3.4 Connect Power, Hose, and Sensors .....      | 9         | 8.3 Preventative Maintenance.....                | 24        |
| 3.5 Display .....                               | 10        | 8.4 System Components .....                      | 25        |
| 3.6 Start/Stop Button.....                      | 11        | 8.5 Accessories & Replacement Parts .....        | 25        |
| <b>4. Selecting Your Settings .....</b>         | <b>12</b> | 8.6 Status Messages .....                        | 25        |
| 4.1 Animal Mode .....                           | 12        | <b>9. Frequently Asked Questions .....</b>       | <b>27</b> |
| 4.2 Volume .....                                | 12        | <b>10. Limited Warranty.....</b>                 | <b>28</b> |
| 4.3 Settings.....                               | 12        | <b>11. Technical Information .....</b>           | <b>28</b> |
| <b>5. Blood Pressure Measurement.....</b>       | <b>16</b> | 11.1 Monitor Model Numbers .....                 | 28        |
| 5.1 Cuff Sizing .....                           | 16        | 11.2 Factory Default Settings .....              | 29        |
| 5.2 Where to Apply the Cuff.....                | 16        | 11.3 Performance Specifications.....             | 29        |
| 5.3 Taking a BP Measurement .....               | 17        | 11.4 Radio Frequency Compliance Requirements     | 30        |
| 5.4 Interval BP Mode.....                       | 17        | 11.5 Electromagnetic Compatibility (EMC).....    | 30        |
| 5.5 STAT Mode.....                              | 18        | <b>Appendix A: Service Screens.....</b>          | <b>33</b> |
| 5.6 Interrupting/Stopping a Measurement .....   | 18        | Service Information.....                         | 34        |
| <b>6. Reviewing and Transferring Data .....</b> | <b>18</b> | Calibration Check.....                           | 34        |
| 6.1 Viewing Stored Measurements .....           | 18        | Air Leak Check.....                              | 35        |
|   |           | Restore Factory Defaults .....                   | 36        |
|   |           | Software Update .....                            | 37        |

# 1. Warnings and Precautions

General warnings and cautions are listed here and repeated where relevant throughout this guide.

A **WARNING** indicates a situation which, if not avoided, could result in serious injury or death.



**WARNING:** DO NOT connect patient hose or monitor to any other devices or connections, especially intravenous (IV) tubes as there is potential for air to be pumped into a blood vessel which could cause serious injury.

**WARNING:** DO NOT use in the presence of flammable anesthetics; this could cause an explosion. This device is not suitable for use in an oxygen enriched environment.

**WARNING:** This monitor is intended for use by healthcare professionals only. This monitor may cause radio interference or may disrupt the operation of nearby equipment. It may be necessary to take mitigation measures such as re-orienting, relocating or shielding the location.

**WARNING:** The cuff should not be applied over a wound as this can cause further injury.

**WARNING:** DO NOT use a defibrillator or ultrasonic device on the patient at the same time as it may affect the operation and/or safety of the patient due to interactions.

**WARNING:** DO NOT immerse the monitor in any fluid or attempt to clean the unit with liquid detergents, cleaning agents, or solvents. This may cause an electrical hazard. Do not use the monitor if accidental wetting occurs. Refer to the cleaning section of this guide for instructions on cleaning.

**WARNING:** Check the limb frequently to ensure that operation of the monitor does not result in prolonged impairment of the circulation of the patient.

**WARNING:** DO NOT apply the BP cuff to a limb being used for IV infusions or any other intravascular access, therapy, or an arteriovenous (A-V) shunt as the cuff inflation can temporarily block the infusion, potentially causing harm to the patient.

**WARNING:** Pressurization of the cuff can temporarily cause loss of functionality of SpO<sub>2</sub> if simultaneously using device on the same limb.

**WARNING:** DO NOT use if device is dropped and/or is damaged. Have a qualified service representative check the unit before using again. Repairs should only be conducted by an authorized SunTech Medical service representative.

**WARNING:** Before performing a procedure when device is not plugged into main power, ensure there is sufficient battery charge. If battery loses charge, device must be plugged into power supply to function.

**WARNING:** The USB port is only a service port and cannot be used to download data or interface with the monitor. When updating the software, the monitor cannot be in use and the accessories should not be contacting the patient.

**WARNING:** The monitor may not be used during electrocautery.

A **CAUTION** indicates a potentially hazardous situation which, if not avoided, may result in minor or moderate injury to the user, patient or damage to the equipment or other property.



**CAUTION:** For use only by or on the direction of a licensed veterinarian. NOT for use on humans.

**CAUTION:** DO NOT use the monitor for any purpose other than specified in this manual without written consent and approval from SunTech Medical.

**CAUTION:** DO NOT use this monitor when oscillometric pulses may be altered by other devices or techniques.

**CAUTION:** DO NOT remove unit covers. Doing so may increase the risk of electrical shock. This monitor does not contain any user serviceable parts. Substitution of a component or accessory different from that supplied may result in measurement error. Repairs should be undertaken only by personnel trained or authorized by SunTech Medical.

**CAUTION:** DO NOT gas sterilize or autoclave this monitor.

**CAUTION:** Too frequent measurements may cause injury to the patient due to blood flow interference.

**CAUTION:** At the end of product life, the monitor, accessories, components and other consumable goods may become contaminated from normal use. Consult local codes and ordinances for proper disposal of equipment and other consumable goods.

**CAUTION:** This device contains a lithium ion battery that contains materials which may be hazardous to human health. DO NOT dispose of battery in domestic waste! Instead, please dispose of in an environmentally responsible way, or return the battery to SunTech Medical. A prepaid return label can be obtained. Please see our website for more information about our environmental policy at <http://www.suntechmed.com/about-suntech/environmental-policy>.











**CAUTION:** Accuracy of any blood pressure measurement may be affected by the position of the subject, the patient's physical condition, and use outside of the operating instructions detailed in this manual. Interpretation of BP measurement should be made only by a veterinarian or trained medical staff. Minimize limb movement during the measurement.





























**CAUTION:** A compressed or kinked connection hose may cause continuous cuff pressure resulting in blood flow interference and potentially harmful injury to the patient. If the cuff fails to deflate, the operator should be instructed on how to remove the cuff.









**CAUTION:** Performance can be affected if used or stored outside the specified temperature and humidity ranges.

**CAUTION:** Replace user replaceable parts that are broken, worn, missing, damaged, incomplete, or contaminated. Contact SunTech Medical for service on parts that are not user replaceable and stop using device until repaired. Failure to repair a damaged product may cause injury to the user and/or patient.

## 2. Icons and Symbols

| Symbol  | Description   | Standard/Source |
|---|---|-----------------|
|  | General Warning Sign                                | ISO 7010-W001   |
|  | Batch Code  | ISO 7000-2492   |
|  | Caution   | ISO 7000-0434A  |
|  | Classification – Class II                           | IEC 60417-5172  |
|  | Refer to Instruction Manual                         | ISO 7010-M002   |
|  | Authorized representative in the European Community | SunTech Design  |
|  | USB-A or USB-B                                      | Industry        |
|  | Direct Current                                      | IEC 60417-5031  |
|  | Alternating Current                                 | IEC 60417-5032  |
|  | Polarity of DC power connector                      | IEC 60417-5926  |
|  | Rechargeable battery                                | IEC 60417-5639  |

|   |  |                |
|---|--|----------------|
|    | Consult Instructions for Use                                     | ISO 7000-1641  |
|    | This product meets the requirements of the applicable Directives | EU Directive   |
|    | Disposal in compliance with WEEE Directive                       | WEEE Directive |
|    | Manufacturer   | ISO 7000-3082  |
|    | Date of Manufacture  | ISO 7000-2497  |
|    | Serial Number  | ISO 7000-2498  |
|    | Cuff index line must fall within range markings                  | SunTech Design |
|    | Arrow should be placed over artery                               | SunTech Design |
|    | Symbol indicating limb circumference                             | SunTech Design |
|    | Index line   | SunTech Design |
|    | Not made with natural rubber latex                               | SunTech Design |
|    | Not made with PVC  | SunTech Design |
|    | Reference Number   | ISO 7000-2493  |
|   | Type BF Applied Part   | IEC 60417-5333 |
|  | Fragile, handle with care  | ISO 7000-0621  |
|  | Humidity Limits  | ISO 7000-2620  |
|  | Temperature Limits   | ISO 7000-0632  |
|  | Keep Dry   | ISO 7000-0626  |
|  | Accesses Settings screen   | SunTech Design |
|  | Small animal mode  | SunTech Design |
|  | Large animal mode  | SunTech Design |
|  | Opens the Icon Menu  | SunTech Design |
|  | Begins Interval BP Mode  | SunTech Design |
|  | Adjusts volume   | SunTech Design |
|  | View Memory  | SunTech Design |
|  | Exits or closes a screen   | SunTech Design |
|  | Goes back to previous screen                                     | SunTech Design |
|  | Deletes all stored memory data                                   | SunTech Design |

|   |   |                                    |
|---|---|------------------------------------|
|  | Averages selected BP readings               | SunTech Design                     |
|  | Begins STAT Mode                            | SunTech Design                     |
|  | Bluetooth                                   | Bluetooth                          |
|  | Begins data transfer                        | SunTech Design                     |
| <b>TIP:</b>   | Provides practical advice for using monitor | SunTech Design                     |
|  | Maximize or minimize a focus screen         | SunTech Design                     |
|  | Power on/off                                | IEC 60417-5009                     |
|  | Start/Stop a BP measurement                 | IEC 60417-5107B<br>IEC 60417-5110B |
|  | Battery Indicator                           | SunTech Design                     |

## 3. Getting to Know SunTech Vet25

### 3.1 Applied Parts

The following are the applied parts of the Vet25:

- BP Cuffs

The Vet25 has been tested with specific parts of the system used within the Patient Environment. The parts of the system that can be used in the patient environment are:

- Vet25 monitor
- All applied parts as defined above
- All accessories as defined in Section 10.5, excluding the AC Adapter

The patient environment is defined in the following diagram:

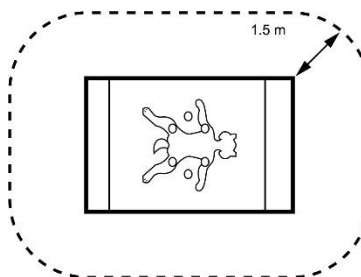

### 3.2 Device Placement



**WARNING:** As with all medical equipment, carefully route patient cabling to reduce the possibility of patient entanglement or strangulation.





**CAUTION:** Do not position the monitor so that it is difficult to access and remove the AC adapter from the electrical supply mains. The power supply is the means of disconnection to the supply mains.

Place the Vet25 monitor in a convenient location to ensure user's ability to monitor the screen continuously. Ensure monitor is placed away from table top edges and route the patient cables so that if pulled, the monitor will not fall.

### 3.3 Front Panel



Power button.

Press once to turn ON. The button is illuminated when power is on.  
To turn OFF, press the button again.

Start/Stop button.

Starts BP measurement. Stops measurement at any time.

### 3.4 Connect Power, Hose, and Sensors



**CAUTION:** Read all warnings, cautions, and instructions provided prior to using the device.

1. Insert AC adapter plug into the Vet25. Plug other end of the AC adapter into a power supply to begin charging the battery. Only use AC Adapter supplied by SunTech Medical.



**WARNING:** The AC adapter must be unplugged and the battery must be disconnected in order to completely disconnect device from power. See Section 8.3 for additional information on battery disconnection.

2. Connect the patient hose to the back of the monitor making sure the connector "clicks" into the locking position by rotating clockwise. For additional information on how to take a BP measurement, see Section 5.



### 3.5 Display

#### Animal Selection Screen

When you turn on your SunTech Vet25, you will see the Animal Selection Screen. Even if you are not ready to measure BP on a patient, select either Large or Small animal so that you can proceed to the Main Screen. This screen can be turned off (see *Animal Selection in Section 4*). Additionally, the animal mode can be toggled using the animal selection icon on the Main Screen.

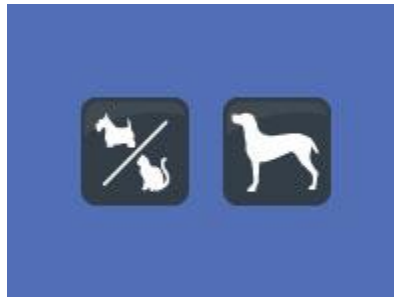

#### Main Screen

After you begin using your Vet25, your main screen will display your most recent patient measurements. Here is a quick overview of the key symbols and numeric values you will see. Prior to the first reading upon power on, the screen will display dashes instead of values.

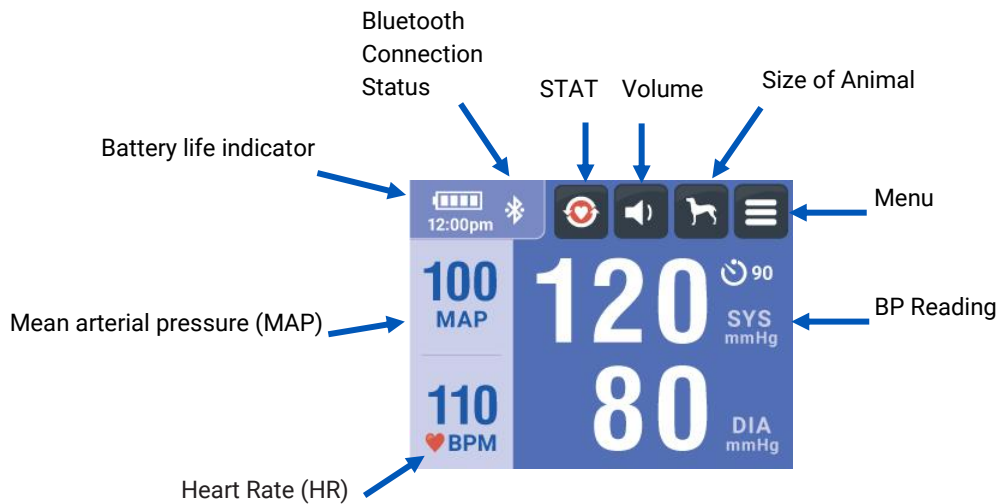

### Icon Menu

After you press on the Menu button on the main screen, the Icon Menu will open. Here you can access various functions and settings of the device. The Icon Menu is not accessible during a BP measurement.



1. Exit Icon Menu
2. Settings  
*For more information on selecting settings, see Section 4.3*
3. Animal Selection
4. Speaker Volume
5. Memory  
*For more information on reviewing and transferring data, see Section 6*
6. STAT Mode  
*For more information STAT BP Mode, see Section 5.5*
7. Interval BP Mode  
*For more information on Interval BP Mode, see Section 5.4*
8. Bluetooth Connect  
*For more information on Bluetooth connection, see Section 6.3*
9. Data Transfer  
*For more information on reviewing and transferring data, see Section 6*

### 3.6 Start/Stop Button

The color of the LED on the START/STOP button indicates the status of the Vet25.



- START/STOP button is magenta during normal operation
- START/STOP button is blue during a BP reading

- START/STOP button is white when in service mode
- START/STOP button is red during an error, when a status message is prompted or the device is unable to connect via Bluetooth

## 4. Selecting Your Settings

### 4.1 Animal Mode

Small Animal Mode should be chosen when taking BP measurements on cats and dogs up to a #3 BP cuff size. This size typically applies to dogs or cats weighing less than 8kg (~17.5 lbs.). Large Animal Mode has been designed for animals requiring a #4 BP cuff or larger. This size typically applies to dogs weighing more than 8 kg (~17.5 lbs.). If a problem arises, try switching animal modes by touching the Animal Selection button on the main screen or in the menu.



### 4.2 Volume

The Vet25 monitor's default setting is Speaker Off so that patients are not disturbed by sounds. To toggle between Speaker Off, Low Volume, and High Volume, press the Speaker button. When sound is OFF, you still will hear a very quiet clicking when you touch buttons but no beeps.



### 4.3 Settings

To access the settings screen, select the settings button (  ) in the Icon Menu.

Clinical Alarms.

Provides access to turning ON and setting clinical alarms.

Interval BP.

Select time between BP measurements in Interval BP Mode.

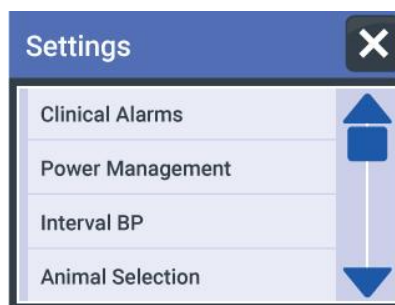

Power Management.

Select how long monitor stays on before Auto OFF shutdown. Auto OFF is disabled when powered by an AC adapter.

Animal Selection.

Time.

Set the time.

Language.

Select desired language.

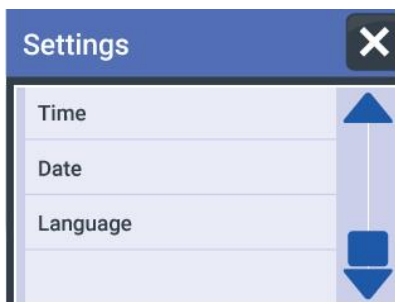

Date.

Set the date.

### Clinical Alarms

The SunTech Vet25 allows clinical alarms for all values (SYS, DIA, MAP, and HR). Factory setting is OFF.

- To change alarm values, select the Settings screen in the Icon Menu, then choose Clinical Alarms.
- Select the parameter of interest.



- Touch On, then Set Alarm Values.
- Touch the numeric range value that you want to adjust. The alarm range cannot be adjusted by dragging the blue bar. The value on the left side represents the value for which all values below that number will trigger the alarm. The value on the right side represents the value for which all values above that number will trigger the alarm.

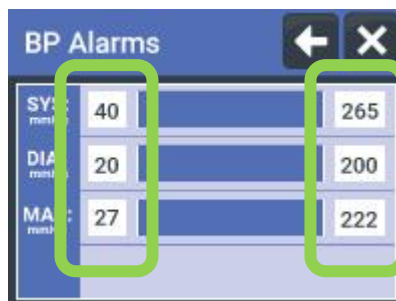

Touch the numbers on the right or left to set the alarm limits.

- Using the keypad, type in the desired value and touch the checkmark.



- To reset to default clinical alarms, touch Use Defaults. For information on the default clinical alarm values, see Section 14.
- When alarm is triggered, values that are outside of the set ranges will turn red on the Main Screen. If speaker is ON, a beep will occur. *For more information on alarms, see Section 10.*

### Power Management

The Vet25 includes an Auto OFF feature which turns the monitor off after a selected period. The Auto OFF timer is disabled when powered by an AC Adapter and during Interval Measurement Mode. To edit the Auto OFF timer, select the Settings screen in the Icon Menu, then choose Power Management. Factory setting is 10 minutes. Auto-off Timer may be set to 5, 10, and 20 minutes or Always ON.

**TIP:** Battery charge may be rapidly depleted if set to always ON.



### Interval BP

To set the time between BP measurements during Interval Mode, select the interval time desired. To access the Interval BP options, select the Settings screen in the Icon Menu, then choose Interval BP.

- Intervals include 1, 2, 3, 4, 5, 10, 15, 30, 60, and 90 minutes

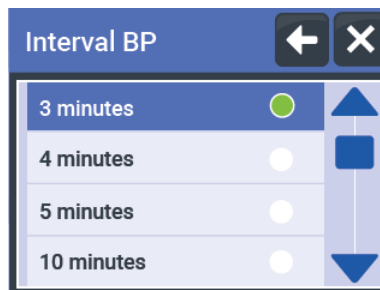

### Animal Selection

The animal selection start up screen can be turned OFF. This is useful for clinics catering to a specific species such as an all cat clinic. To change the animal selection screen options, select the Settings screen in the Icon Menu, then choose Animal Selection.



### Time

To set the internal clock, select the Settings screen in the Icon Menu, then choose Time.

- Two time formats are available: AM/PM and 24 Hour.
- Select the desired time format and touch Continue.



- Use the + and – buttons to select the hour and minute. In AM/PM format, touch the AM or PM button to toggle between them.



- To exit without changing the time, touch Cancel. To save the time, select Set.

### Date

To set the date, select the Settings screen in the Icon Menu, then choose Date.

- Two date formats are available: MM.DD.YY and DD.MM.YY
- Select between the two date formats and touch Continue.

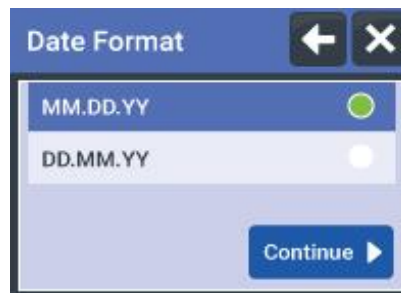

- Use the + and – buttons to set the day, month, and year and touch Set to save the date.



- Touch Cancel to return to the Date Format screen without changing the date. Press X to exit to the main screen.

### Language

Multiple languages are available including English, French, Italian, German, Spanish and Brazilian Portuguese. To access the languages, select the Settings screen in the Icon Menu, then choose Language.

- Touch the desired language to select it. Press X to save and exit.



## 5. Blood Pressure Measurement

### 5.1 Cuff Sizing

The SunTech Vet25 comes with a variety of different BP cuff sizes. Each cuff contains important markings that help with selecting the right cuff size. These are SunTech designed symbols.

**ARTERY**



Make sure this part of cuff is placed over the patient's artery.



When the cuff is wrapped around the patient's limb, its Index Marker should fall within this line.



When you wrap the cuff around the patient's limb, the Index Marker should fall within the Range Marker on the inside of the cuff.



Indicates limb circumference range of the cuff.



Not made with natural rubber latex.



Not made with PVC.

**TIP:** When more than one cuff size fits the limb, always choose the larger size for more accurate measurements. When a cuff is too small, it can cause BP values to be overestimated.

An alternative sizing method is to measure the circumference of the limb and choose a cuff whose width is 40% of the circumference for dogs and 30% for cats.

### 5.2 Where to Apply the Cuff



**WARNING:** The cuff should not be applied over a wound as this can cause further injury.

SunTech recommends that the cuff be placed on a front limb while the patient is lying on the right or left side. This helps ensure that the cuff is at heart level, which is best for measurement accuracy. Also, the patient is less likely to



retract the front limb when the cuff gently squeezes it during the measurement. The cuff should be placed so that its artery marker aligns with the limb artery.

**Alternate Patient Positioning:** If the patient seems more comfortable seated, position the cuff as described above and hold up the limb during the BP measurement. This will help keep the cuff at heart level and relax the patient's muscles. If the patient appears agitated enough to bite or scratch, or is standing, the base of the tail is an acceptable alternate location.

### 5.3 Taking a BP Measurement

1. Position patient so that they are lying down, seated, or held. Place the cuff on the limb making sure not to place it over a joint. Connect cuff hose to monitor hose.

**TIP:** The success of the BP measurement is dependent on choosing the correct cuff and attaching it to the patient correctly. The cuff is the sensor so make sure to snugly fit the cuff as this provides better signals to the monitor.

2. Press the Power Button to turn on the Vet25. Select Large or Small animal size.

**TIP:** To change animal size after initial selection, touch the Animal Selection icon on Main Screen to toggle between Large and Small. *For more information on selecting animal size, see Section 4.*

3. Allow patient to acclimate for approximately 5 minutes in a quiet area. Press START/STOP button to start blood pressure measurement. START/STOP button turns blue during measurement. Reading is complete when START/STOP button returns to magenta. Main Screen will show systolic (SYS) and diastolic (DIA) values, plus mean arterial pressure (MAP) and heart rate (HR) in beats per minute.

**TIP:** During a BP reading, the Icon Menu is not available. To access the Icon Menu, either wait until the BP reading is complete or stop the reading by pressing the START/STOP button.

**TIP:** When a BP reading is in progress, pressing the START/STOP button will immediately stop the measurement and deflate the cuff.

### 5.4 Interval BP Mode

In Interval BP Mode, the SunTech Vet25 automatically takes a BP reading at set time intervals. The time interval can be changed through the Interval BP settings (*see Section 4*).

- To start taking BP measurements in Interval Measurement Mode, enter the Icon Menu, then touch the Interval BP icon: 
- The Icon Menu will close and the first BP measurement will automatically begin. Once the BP reading has finished, the device will wait the set amount of time before automatically taking another BP reading.
- When the SunTech Vet25 is in Interval Measurement Mode, a clock icon will appear on the screen, indicating the set time interval.
- An additional BP reading can be taken by manually pressing the START/STOP button in between Interval BP readings.
- During a BP reading, the Icon Menu is not available.
- To exit Interval Measurement Mode, touch the Interval BP icon in the Icon Menu or press the START/STOP button during a BP measurement.



**TIP:** For information on setting the amount of time between interval measurements, see Section 4.3.

## 5.5 STAT Mode



**WARNING:** Check the limb frequently to ensure that operation of the monitor does not result in prolonged impairment of the circulation of the patient.

During STAT Mode, the SunTech Vet25 will automatically take continuous BP measurements for 10 minutes.

- To enter STAT Mode, select the STAT icon at the top of the Main Screen.
- Alternatively, enter the Icon Menu, then touch the STAT icon.
- When the device is in STAT Mode, the STAT icon is displayed on the main screen.
- During a BP reading, the Icon Menu is not available.
- To exit STAT Mode, touch the STAT icon again or press the START/STOP button while a BP measurement is in progress. STAT Mode will automatically stop after 10 minutes.



## 5.6 Interrupting/Stopping a Measurement

To stop a measurement while in progress, touch the START/STOP button. When a BP reading is in progress, pressing the START/STOP button will immediately stop the measurement and deflate the cuff. An abort message will appear on the screen and a short beep will sound if volume is on. START/STOP button returns to magenta and monitor gets ready to start a new reading.

# 6. Reviewing and Transferring Data

## 6.1 Viewing Stored Measurements

To take additional BP readings, press START/STOP again.

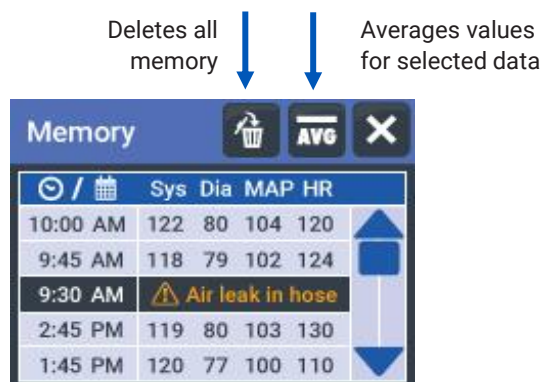

To view previous readings, touch Menu, then touch the Memory icon. Select the parameters to view. The time and date will alternate. Up to 960 measurements can be stored in memory.

## 6.2 Averaging Measurements

The BP data can be averaged in the memory screen. To average measurements, touch the rows with the measurements you wish to average. Selected rows will turn green. To unselect a measurement, touch its row a second time. Limit the number of measurement rows averaged to under one hundred (100) to avoid incorrect results due to too many measurements.

Average of selected readings shows on top row with "AVG" as the identifier.

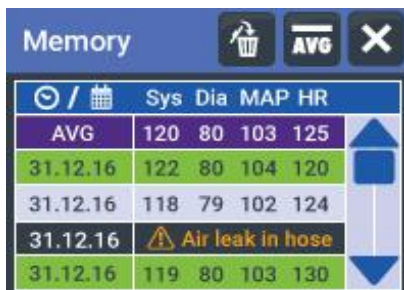

| 🕒 / 📅    | Sys | Dia              | MAP | HR  |
|----------|-----|------------------|-----|-----|
| AVG      | 120 | 80               | 103 | 125 |
| 31.12.16 | 122 | 80               | 104 | 120 |
| 31.12.16 | 118 | 79               | 102 | 124 |
| 31.12.16 | ⚠️  | Air leak in hose |     |     |
| 31.12.16 | 119 | 80               | 103 | 130 |

## 6.3 Bluetooth Connection

The SunTech Vet25 can pair with a PC within a 30-foot radius to transfer data via Bluetooth. To pair with a PC, the Vet Data Capture PC application must first be installed on the PC. The application is available for download from the SunTech website at <https://www.suntechmed.com/vet25-data-capture>. The PC application is supported on Windows 10, Windows 8.1, and Windows 7.

### Installation and Setup

1. Download the Vet Data Capture application from the SunTech website. Double click on the zip file to extract the folder. The folder can be dragged onto the desktop for easy access to the application.
2. Insert the USB Bluetooth Transmitter into an open USB port on the PC. The computer will automatically install the Bluetooth USB.

### Pairing with the Vet25

1. To turn on Bluetooth on the Vet25, touch the Bluetooth icon (📶) in the Icon Menu. The monitor will automatically attempt to pair with the other device. While the device is connecting via Bluetooth, the Start/Stop button will flash blue light. Continue to step 2 while the device is flashing blue light.
2. Open the Vet Data Capture application by double clicking on the file with the purple paw icon:

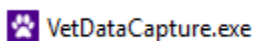

3. When the Vet Data Capture application opens, select a Vet25 for pairing. Identify the Vet25 using the last four digits of the serial number, found on the bottom of the device. *Continue to Section 6.4 for Data Transfer instructions.*

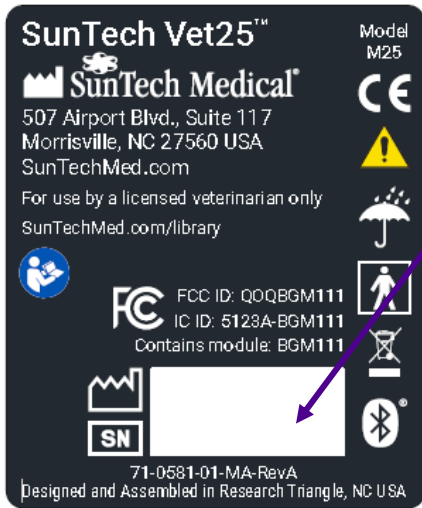

The last 4 digits of the serial number should match.

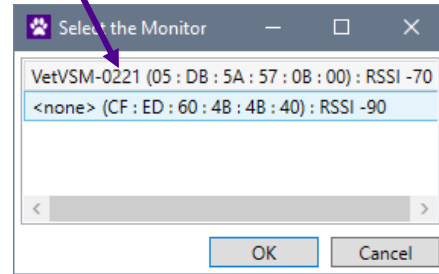

**TIP:** If the device is unable to connect within 90 seconds, a message will be displayed. Touch Try Again to re-attempt to connect.

**TIP:** During Bluetooth pairing and data transfer, ensure that the Auto Off timer is OFF to avoid the Vet25 turning off during pairing or data transfer. *For instructions on changing the Auto Off timer, see section 4.3*

To turn off Bluetooth, touch the Bluetooth icon in the Icon Menu. When Bluetooth is off, the icon will be greyed out in the Icon Menu.

## 6.4 Data Transfer

Once a Bluetooth connection is established with a PC, data can be transferred to the Vet Data Capture PC application.

- To begin a data transfer, touch the Data Transfer icon (  ) in the Icon Menu of the Vet25. A status message will pop up during the transfer on the Vet25 and will appear at the bottom of the Vet Data Capture application.
- When data transfer is complete, the data will appear in the Vet Data Capture application. A "Transfer Complete" status message will appear on the Vet25. Select OK to clear the status message.

**TIP:** The Vet Data Capture PC application does not retain data when closed. *To ensure data is saved, follow instructions in section 6.5.*

## 6.5 Reviewing Data and Creating Reports

The SunTech PC application allows the user to create reports of patient data. Via the Bluetooth connection, all data is downloaded from the Vet25 and displayed on the software main screen in tabular format with the latest data at the top of the screen. Within the PC application, a patient name, patient ID, species, and age can be added.

### Saving Patient Information

- Select the data points for a patient by holding Ctrl and clicking on each one. For large amounts of consecutive data points, hold Shift and click the first and last data points to be included.
- Use the text bars at the top of the screen to enter Patient Name, Patient ID, Species, and Age.

- Click the Apply button to save the Patient Name, Patient ID, Species, and Age to the selected data points.
- To correct an error, entries can be overwritten. Select the data point with incorrect information and enter the correct information into the text bars. Selecting Apply will save the new information to the data point.

Selected portions of data can be organized into a report format that includes patient information, table of most recent vital sign data, trend graphs and notes. This report can be printed or exported as a PDF file. The tabulated raw data can also be exported as a CSV file. The Vet Data Capture PC application does not retain data when closed. To ensure data is saved, follow instructions below to export the data to a PDF or CSV file.

### Configuring Settings

To change the date format, time format, or temperature units within the Vet Data Capture application, open the “Configure” menu from the top of the screen.

- “Date Format” provides the option to switch between M/d/yyyy and d.M.yyyy date formats

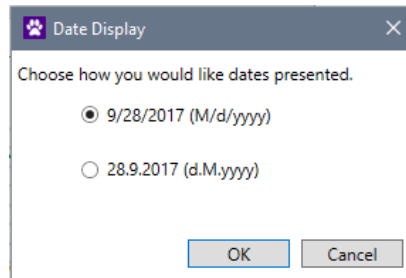

- “Time Format” provides the option to switch between time formats.

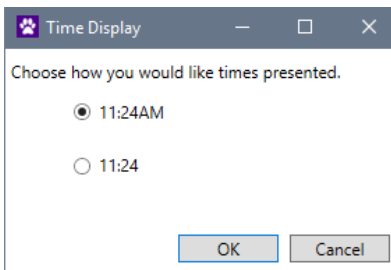

- “Temperature Units” provides the option to switch between Celsius and Fahrenheit

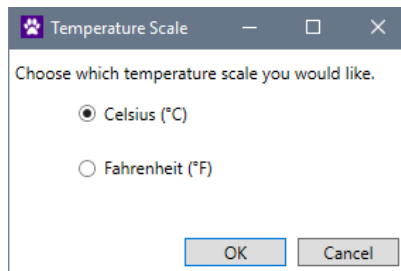

## Creating a Report

1. Once data transfer is complete, select the data points to be included in the report by holding Ctrl and clicking on each one. For large amounts of consecutive data points, hold Shift and click the first and last data points to be included.

Patient Name \_\_\_\_\_

| Date      | Time    | SYS | DIA | MAP | HR  | SpO2% | Temp | Error |
|-----------|---------|-----|-----|-----|-----|-------|------|-------|
| 8/24/2001 | 12:47AM | 111 | 74  | 86  | 108 | 0     | -    |       |
| 8/23/2001 | 1:54AM  | 112 | 69  | 80  | 90  | 0     | -    |       |
| 8/23/2001 | 1:34AM  | 138 | 80  | 95  | 103 | 0     | -    |       |
| 8/23/2001 | 1:12AM  | 88  | 36  | 48  | 82  | 0     | -    |       |
| 8/23/2001 | 12:49AM | 118 | 91  | 99  | 91  | 0     | -    |       |
| 8/22/2001 | 6:40AM  | 74  | 62  | 65  | 172 | 0     | -    |       |
| 8/22/2001 | 4:45AM  | 114 | 87  | 95  | 76  | 0     | -    |       |
| 8/22/2001 | 3:17AM  | 153 | 130 | 136 | 119 | 0     | -    |       |

**TIP:** Only 24 hours of data can be graphed at one time. If graph contains a message saying “Maximum Limit Exceeded,” review data selected to ensure that a 24-hour period is not exceeded.

2. Click “Report”
  - a. Use the checkboxes on the left-hand side of the screen to choose if charts or a data table are included in the report.
  - b. Select “Print” to print report. Select “PDF” to save report as a .pdf file to the computer.

Once data is selected, the following actions are also available:

- To print report, click “Data” and choose “Print Report”
- To save report as a PDF file, click “Data” and choose “Create PDF”
- To save report as a CSV file, click “Data” and choose “Create CSV”

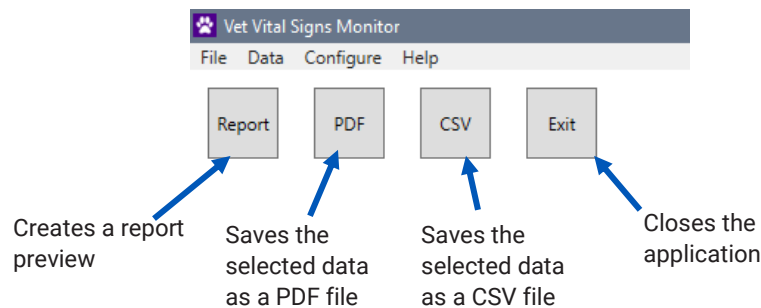

## 7. Alarms

### 7.1 Technical Alarms

A technical alarm occurs when an error occurs during a BP measurement.

During a technical alarm, an audible tone will sound and the parameter that is malfunctioning will display dashes. Vital sign values that are outside published values will not be displayed.

When there is an error in BP measurement, values for SYS and DIA are replaced with dashes, the START/STOP button turns red, and a long audible beep sounds if volume is on. A status message will be displayed to assist with troubleshooting the problem. *For a list of status messages, see Section 10.*

## 7.2 Clinical Alarms

Clinical alarms occur when a measured value meets or exceeds the high or low limit set for that parameter. The default mode for clinical alarms is OFF. See Section 4 for instructions on turning on clinical alarms and setting clinical alarm values. When a BP clinical alarm occurs, the measurement value will display in red and a long beep will sound. If it is appropriate for the patient, the alarms can be turned off. Alarms can be silenced by toggling the volume button to OFF. Always ensure that appropriate resuscitation equipment and personnel are available during the procedure. Always select alarm ranges that are appropriate for the patient and procedure. All alarms indicate a potential increased risk of injury if the test is continued.

To test the clinical alarms, turn the volume of the monitor on and set the alarm at a value likely to be exceeded with the next reading. Perform the reading. When the value exceeds the limit set, the alarm should display and a beep should sound.

# 8. Taking Care of the SunTech Vet25

## 8.1 Battery



**WARNING:** The internal user-replaceable battery must be plugged into a power source to maintain the battery to a full charge state. Check the battery charge status periodically, especially before a procedure where the monitor is not connected to a power source.

The Vet25 has an internal user-replaceable battery that is charging whenever the monitor is plugged into a power source. The last segment of the battery indicator will turn red when battery charge is low. When Interval BP measurements are set for every 5 minutes, a fully charged battery should last at least 4 hours before requiring recharging. If only taking manual BP measurements, a fully charged battery should last for at least 150 BP measurements before requiring recharging. Fully charging the battery should take under 6 hours.

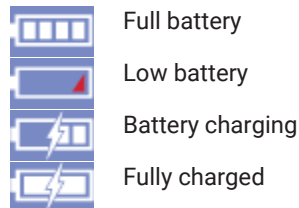

## 8.2 Cleaning

### Cleaning the Vet25



**WARNING:** DO NOT immerse the monitor in any fluid or attempt to clean the unit with liquid detergents or solvents. This may cause an electrical hazard. Do not use the monitor if accidental wetting occurs.

As needed, clean the display using a soft, lint-free cloth sprayed with an alcohol-free glass cleaner. Dampen a soft cloth with mild medical grade disinfectant and wipe the monitor to remove surface dust and dirt.

### Cleaning the Protective Armour

Wash in warm, soapy water.

Due to the manufacturing process, minor molding blemishes may be present on the protective armour. These blemishes will not impact the functionality of the armour or the monitor and are not considered defects of the product.

## 8.3 Preventative Maintenance



**WARNING:** Do not disassemble the unit. There are no user serviceable parts except for the battery. Refer to qualified service personnel.

### System Self Checks

The Vet25 performs a range of system checks during normal operation. If the monitor detects a problem, it will display a status message recommending a troubleshooting action or to contact SunTech Customer Service.

### Replaceable Parts



**CAUTION:** Immediately replace parts that are broken, worn, missing, incomplete, damaged, or contaminated.

On a routine basis, inspect the monitor, cuffs, and hoses for cracks, fraying, or kinks. Immediately replace any damaged part. Device can function without a battery. However, if battery fails to maintain a charge, replace the battery. Before replacing the battery, make sure the device is turned off and disconnected from patient. Do not replace the battery without removing power supply from wall. The start/stop button does not remove power from the system. To replace the battery, use a screwdriver to unscrew the screw and open the battery bay door on the bottom of the device. Remove battery by disconnecting the electrical connector. Replace battery and reconnect the electrical connector. Replace battery bay door and secure with screw. Before use, battery must be fully charged.

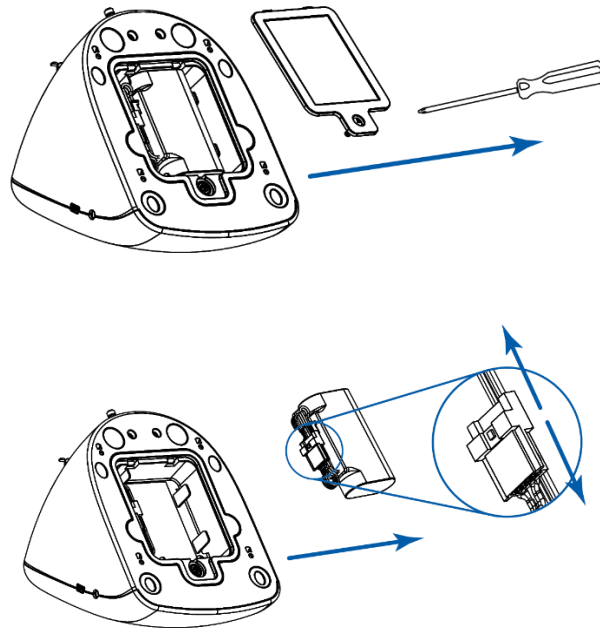

**CAUTION:** Use only approved accessories. Replace battery only with SunTech part number 98-0900-01.

### Expected Service Life

Monitor: 7 years (dependent upon internal BP pump usage)

Lithium-ion Battery: 250 cycles (before capacity falls below 80% of original capacity)



## 8.4 System Components

Your Vet25 System should contain the following items.

| Vet25 System                  | Standard Qty. |
|-------------------------------|---------------|
| Vet25 System Monitor          | 1             |
| Patient Hose, 6ft (1.8m)      | 1             |
| Vet System Cuff Kit (6 cuffs) | 1             |
| Vet25 User Manual             | 1             |
| AC Adaptor, Universal         | 1             |
| Protective Armour             | 1             |

## 8.5 Accessories & Replacement Parts

Contact your sales representative to purchase the following items:

| Description                          | Part Number | Details                                   |
|--------------------------------------|-------------|---|
| #1 Cuff                              | 98-0400-80  | 3 – 6 cm, white, non-locking, box of 20   |
| #2 Cuff                              | 98-0400-81  | 4 – 8 cm, white, non-locking, box of 20   |
| #3 Cuff                              | 98-0400-82  | 6 – 11 cm, white, non-locking, box of 20  |
| #4 Cuff                              | 98-0400-83  | 7 – 13 cm, white, non-locking, box of 20  |
| #5 Cuff                              | 98-0400-84  | 8 – 15 cm, white, non-locking, box of 20  |
| #6 Cuff                              | 98-0400-F1  | 12 – 19 cm, white, non-locking, box of 20 |
| #7 Cuff                              | 98-0400-F3  | 17 – 25 cm, white, non-locking, box of 20 |
| Vet Cuff Pack, Slip Luer, Sizes #1-6 | 98-0240-00  | Pack of 6 cuffs: 1 of each size 1-6       |
| Patient Hose, 6 ft (1.8 m)           | 91-0028-75  | 6 ft (1.8 m), black, individual           |
| Patient Hose, 10 ft (3 m)            | 91-0028-76  | 10 ft (3 m), black, individual            |
| AC Adapter                           | 19-0020-00  | Power Supply, Universal                   |
| Armour in Flamingo Pink              | 39-0195-00  | Protective cover, pink, individual        |
| Armour in Peacock Blue               | 39-0195-01  | Protective cover, blue, individual        |
| Armour in Tree Frog Green            | 39-0195-02  | Protective cover, green, individual       |
| Rechargeable Lithium-Ion Battery     | 98-0900-01  | 7.2 V, 2.2 Ah, 15.8 Wh                    |

## 8.6 Status Messages

If the SunTech Vet25 has a problem performing a task, a short beep will occur (if speakers are ON), the START/STOP button will turn Red and a Status Message will appear on the monitor screen. Take action as directed on the screen, or as suggested in the table below.

| Status Message       | Reason  | Solution   |
|----------------------|---|--|
| Air Leak             | There is a leak in the cuff, hose or monitor. Also possible if cuff or hose is not attached to the monitor.             | <ul style="list-style-type: none"> <li>Check that the hose is connected to the monitor and cuff.</li> <li>Check that the cuff is properly tightened.</li> <li>Check that the cuff is in the correct position.</li> <li>Check that the cuff is not leaking air.</li> <li>Check that the hose connections are not damaged or loose.</li> </ul> |
| Value out of Range   | The blood pressure value is outside of SunTech Vet25's published ranges.  | <ul style="list-style-type: none"> <li>Make sure you are using the proper cuff size.</li> <li>Patient may have been moving too much.</li> <li>Check that the cuff is properly tightened and in proper position.</li> </ul>   |
| Poor Signal Quality  | Monitor is not receiving a strong signal from patient. Also possible if a rapid deflation occurs during a measurement.  | <ul style="list-style-type: none"> <li>Check that cuff is in correct position.</li> <li>Check the patient.</li> <li>Check that cuff is properly tightened.</li> <li>Check that correct size cuff is used.</li> </ul>   |
| Artifact Detected    | Monitor is picking up on unexpected noise or movements.   | <ul style="list-style-type: none"> <li>Check animal mode. It might be on wrong setting.</li> <li>Check patient for motion, trembling. Too much movement.</li> <li>Check that cuff is in correct position.</li> <li>Check that correct size cuff is used.</li> </ul>  |
| Measurement Too Long | The monitor is not detecting strong and consistent signals from the patient for an extended time period.                | <ul style="list-style-type: none"> <li>Check to ensure cuff is fitting snugly on patient and is positioned properly.</li> <li>Check that cuff is in correct position.</li> <li>Check patient for moving, trembling.</li> </ul>   |
| Check Batteries!     | Battery power is low.   | <ul style="list-style-type: none"> <li>See the battery life indicator on the Main Screen.</li> <li>Replace batteries if needed.</li> </ul>   |
| Air Blockage         | Air is not able to pass through the hose or cuff properly.  | <ul style="list-style-type: none"> <li>Check that hose has no sharp bends and is not pinched.</li> <li>Check that patient is not lying or stepping on cuff.</li> <li>Check that cuff is in correct position.</li> </ul>  |
| Cuff Overpressure    | Pressure in the cuff briefly exceeded 300 mmHg due to patient movement, air blockage or using a cuff that is too small. | <ul style="list-style-type: none"> <li>Check that correct size cuff is being used.</li> <li>Check that hose has no sharp bends and is not pinched.</li> <li>Check that patient is not lying or stepping on cuff.</li> <li>Ensure patient is not moving excessively.</li> </ul>   |
| Monitor Not Ready    | Monitor is preparing for next measurement or may need service.  | Touch START/STOP to start a new measurement. For repeated errors, calibration or service may be required.  |
| System Failure       | A monitor system has failed.  | Service is required.   |
| Error!               | Connection with the Bluetooth pairing device failed.  | Check to ensure that the device is within range (30 feet) of the pairing device.   |

Check that the pairing device has Bluetooth turned on and is advertising.

Transfer Error      Bluetooth paired device became disconnected.

Check to ensure that the device is within range (30 feet) of the pairing device.

Check that the pairing device has Bluetooth turned on and is advertising.

## 9. Frequently Asked Questions

How many measurements can I store in Memory?

You can store up to 960 measurements. The monitor has a revolving memory. When you take your 51st measurement, it will be listed as measurement #1.

How do I delete BP data from memory?

Select the Memory button and touch the Delete button.

Before the memory is cleared, you will be asked to confirm or cancel the deletion. When you clear the Memory, you delete all measurements.

For medium-sized dogs, which animal mode do I choose?

Use cuff size as the determination factor. If a #3 cuff or smaller is the best fit, choose small animal mode. If #4 or larger, choose large animal mode.

How do I choose the correct cuff size?

Wrap the cuff around the patient's limb and make sure the index line falls within the range marker. If two different cuff sizes fit the patient, choose the larger size.

How long will the batteries last?

During continuous monitoring of SpO<sub>2</sub> and temperature, with an Interval BP set for every 5 minutes, a fully charged battery should last at least 4 hours before requiring recharging. If only taking manual BP measurements, a fully charged battery should last for at least 150 BP measurements before requiring recharging. Fully charging the battery should take under 6 hours. Battery life is very dependent on the touch screen display ON time. To maximize life, SunTech suggests setting the Auto OFF timer to 1 minute.

Can I use this monitor on awake and anesthetized animals?

Yes. The Vet25 can be used on anesthetized animals as well as awake animals.

How do I keep the cuff from slipping down the limb or coming off?

Attach the cuff as tight as possible. Extra attention will be needed on species with dense or thick fur. If the cuff will not stay attached, check the hook & loop for fur and remove if possible.

Are there other power options?

Yes. The device is provided with a mains power supply that recharges the internal battery when connected. When the monitor is not connected to the power supply, the battery will allow the unit to be portable for use.

What are the minimum and maximum cat & dog weights when taking measurements with the Vet25?

There are none. Any cat or dog that has a limb that fits within the cuff ranges is acceptable.

## 10. Limited Warranty

SunTech Medical, Inc. provides to the original purchaser the following limited warranty from date of invoice.

Monitors 24 months

Cuffs/Hoses 90 days

SunTech Medical, Inc. warrants each instrument to be free from defects in material and workmanship. Liability under this warranty covers servicing of the instrument when returned from the customer's facility within the United States prepaid to the factory. SunTech Medical, Inc. will repair any component(s) or part(s) that it finds to be defective during the period of this limited warranty. Should a defect become apparent, the original purchaser should first notify SunTech Medical, Inc. of the suspected defect. The instrument should be carefully packaged and shipped prepaid to:

SunTech Medical, Inc.  
Service Department  
507 Airport Boulevard, Suite 117  
Morrisville, NC 27560 USA  
Tel: 800.421.8626  
919.654.2300  
Fax: 919.654.2301

SunTech Medical, Ltd.  
Service Department  
Oakfield Industrial Estate  
Eynsham, Oxfordshire OX29 4TS UK  
Tel: 44 (0) 1865.884.234  
Fax: 44 (0) 1865.884.235



This limited warranty is void if the instrument has been damaged by accident, misuse, negligence, act of God or serviced by any person not authorized by SunTech Medical, Inc. It contains the entire obligation of SunTech Medical, Inc. and no other warranties expressed, implied or statutory are given. No representative or employee of SunTech Medical, Inc. is authorized to assume any further liability or grant any further warranties except as herein.

## 11. Technical Information

### 11.1 Monitor Model Numbers

| Part Number | Model Number | Model Description                 |
|-------------|--------------|-----------------------------------|
| 99-0170-00  | M25          | Vet25 with Flamingo Pink Armour   |
| 99-0170-01  | M25          | Vet25 with Peacock Blue Armour    |
| 99-0170-02  | M25          | Vet25 with Tree Frog Green Armour |

## 11.2 Factory Default Settings

| Parameter Name | Default Value |
|----------------|---------------|
|----------------|---------------|

|                        |     |
|------------------------|-----|
| Clinical Alarms Status | OFF |
|------------------------|-----|

|                           |         |
|---------------------------|---------|
| Clinical Alarms – low SYS | 40 mmHg |
|---------------------------|---------|

|                            |          |
|----------------------------|----------|
| Clinical Alarms – High SYS | 265 mmHg |
|----------------------------|----------|

|                           |         |
|---------------------------|---------|
| Clinical Alarms – low DIA | 20 mmHg |
|---------------------------|---------|

|                            |          |
|----------------------------|----------|
| Clinical Alarms – High DIA | 200 mmHg |
|----------------------------|----------|

|                           |         |
|---------------------------|---------|
| Clinical Alarms – low MAP | 27 mmHg |
|---------------------------|---------|

|                            |          |
|----------------------------|----------|
| Clinical Alarms – High MAP | 222 mmHg |
|----------------------------|----------|

|                          |        |
|--------------------------|--------|
| Clinical Alarms – low HR | 25 bpm |
|--------------------------|--------|

|                           |         |
|---------------------------|---------|
| Clinical Alarms – High HR | 300 bpm |
|---------------------------|---------|

|                |     |
|----------------|-----|
| Speaker Status | OFF |
|----------------|-----|

|                |            |
|----------------|------------|
| Auto OFF Timer | 10 minutes |
|----------------|------------|

|                  |           |
|------------------|-----------|
| Interval BP Rate | 3 minutes |
|------------------|-----------|

|          |         |
|----------|---------|
| Language | English |
|----------|---------|

|                          |    |
|--------------------------|----|
| Startup Animal Selection | ON |
|--------------------------|----|

|             |            |
|-------------|------------|
| Date Format | MM/DD/YYYY |
|-------------|------------|

|             |         |
|-------------|---------|
| Time Format | 12-hour |
|-------------|---------|

|                  |     |
|------------------|-----|
| Bluetooth Status | OFF |
|------------------|-----|

## 11.3 Performance Specifications



**CAUTION:** Performance can be affected if used or stored outside the specified temperature and humidity ranges.

Operating Conditions: Vet25 Monitor: 0°C to 50°C, 15% to 90% non-condensing humidity

Storage Conditions: -20°C to 65°C, 15% to 90% non-condensing humidity

Altitude: Measurement accuracy not affected by altitude

Power Source: Lithium-ion Battery and/or AC Adapter

Input Voltage Range: Universal (100 to 240 Vac)

Input Frequency Range: Universal (50 to 60 Hz)

Input Efficiency rating: DoE Level VI

Isolation Classification: Class II

Output Voltage: 12 Vdc

Output Current: 0 to 2.5 A

Protection from electrical shock: Class 2  
Duty Cycle: Continuous use  
Battery: 7.2 V, 2.2 Ah, 15.8 Wh  
Dimensions: 6.25" x 5" x 5.25" (15.9cm x 12.7cm x 13.3cm)  
Weight: 2.1 lb (0.95 Kg) with battery

### BP Specifications

Method of Measurement: Oscillometric  
Blood Pressure Range: Systolic: 40 – 265mmHg  
MAP: 27 – 222mmHg  
Diastolic: 20 – 200mmHg  
Pulse Rate Range: 25 to 300 BPM (Beats Per Minute)  
Pulse Rate Units: Beats per minute  
Cuff Deflate Rate: Deflation step size varies with heart rate, cuff pressure and cuff volume  
Initial Inflation Pressure: 180 mmHg (default)  
Subsequent initial inflation: previous Systolic + 30 mmHg  
Transducer Accuracy:  $\pm 3$  mmHg between 0 mmHg and 300 mmHg  
Transducer Calibration: Recommended bi-annually or if a calibration problem is suspected

## 11.4 Radio Frequency Compliance Requirements

This device contains a transmitter module identified by FCC ID: QQQBGM111 and Industry Canada: IC 5123A-BGM111. It has been tested and found to comply with the limits for a Class B device. Changes or modifications not expressly approved by the manufacturer could void the user's authority to operate the equipment. This device complies with Part 15 of the FCC Rules for the United States. Operation is subject to the following 2 conditions:

- 1) This device may not cause interference; and
- 2) This device must accept any interference, including interference that may cause undesired operation of the device.

### Radio Equipment Directive (RED)

This is a Class I device that contains a wireless transmitter which can be used in at least one EU member state. There are no restrictions of use.

## 11.5 Electromagnetic Compatibility (EMC)

Changes or modifications to the SunTech Vet25 that are not approved by SunTech Medical may cause EMC interference problems with this or other equipment.

### EMC Statement

This equipment needs special precautions regarding EMC and needs to be installed and put into service per the EMC information provided in this document. This equipment has been tested and found to comply with the limits for medical devices to IEC60601-1-2: 2007. These limits are designed to provide reasonable protection against harmful interference in a typical medical installation. This equipment generates, uses and can radiate radio frequency energy and, if not installed and used in accordance with the instructions, may cause harmful interference to other devices in the vicinity. However, there is no guarantee that interference will not occur in a particular installation. If this equipment does cause harmful interference to other devices, which can be determined by turning the equipment off and on, the user is encouraged to try to correct the interference by one or more of the following measures:

- Reorient or relocate the receiving device.
- Increase the separation between the equipment.
- Connect the equipment into an outlet on a circuit different from which the other device(s) are connected.
- Consult the manufacturer or field service technician for help.
- Portable and mobile RF communications equipment can affect Medical Electrical Equipment.



**WARNING:** Use of accessories, transducers, and cables other than those specified may result in increased emissions or decreased immunity of the Vet25.

**WARNING:** The Vet25 should not be used adjacent to or stacked with other equipment. If adjacent or stacked use is necessary, the Vet25 should be observed to verify normal operation in the configuration in which it will be used.

**WARNING:** This equipment/system is intended for use by healthcare professionals only. This equipment/ system may cause radio interference or may disrupt the operation of nearby equipment. It may be necessary to take mitigation measures, such as re-orienting or relocating the Vet25 or shielding the location.

| Guidance and manufacturer's declaration – electromagnetic emissions  |            |  |
|--|------------|--|
| The Vet25 is intended for use in the electromagnetic environment specified below.<br>The customer or the user of the Vet25 should assure that it is used in such an environment. |            |  |
| Emissions test   | Compliance | Electromagnetic environment – guidance   |
| RF emissions<br>CISPR 11   | Group1     | The Vet25 uses RF energy only for its internal function. Therefore, its RF emissions are very low and are not likely to cause any interference in nearby electronic equipment.   |
| RF emissions<br>CISPR 11   | Class B    | The Vet25 is suitable for use in all establishments, including domestic establishments and those directly connected to the public low-voltage power supply network that supplies buildings used for domestic purposes. |
| Harmonic emissions<br>IEC 61000-3-2  | Class A    |  |
| Voltage fluctuations/flicker emissions<br>IEC 61000-3-3  | Complies   |  |

| Guidance and manufacturer's declaration – electromagnetic immunity  |  |  |  |
|---|--|--|--|
| The Vet25 is intended for use in the electromagnetic environment specified below. The customer or user of the Vet25 should assure that it is used in such an environment. |  |  |  |
| Immunity test   | IEC 60601 test level                                   | Compliance level                                       | Electromagnetic environment - guidance   |
| Electrostatic discharge (ESD)<br>IEC 61000-4-2  | ±6 kV contact<br>±8 kV air                             | ±4 kV contact<br>±4 kV air                             | Floors should be wood, concrete or ceramic tile. If floors are covered with synthetic material, the relative humidity should be at least 40% |
| Electrical fast transient/burst<br>IEC 61000-4-4  | ±2 kV for power supply lines and patient coupled lines | ±2 kV for power supply lines and patient coupled lines | Mains power quality should be that of a typical commercial or hospital environment.  |

|  |   |   |   |
|--|---|---|---|
| Surge<br>IEC 61000-4-5   | ±1 kV line(s) and neutral   | ±1 kV line(s) and neutral   | Mains power quality should be that of a typical commercial or hospital environment.   |
| Voltage dips, short interruptions and voltage variations on power supply input lines<br>IEC 61000-4-11 | 5 % UT (>95 % dip in UT) for 0,5 cycle<br>40 % UT (60 % dip in UT) for 5 cycles<br>70 % UT (30 % dip in UT) for 25 cycles<br><5 % UT (>95 % dip in UT) for 5s | 5 % UT (>95 % dip in UT) for 0,5 cycle<br>40 % UT (60 % dip in UT) for 5 cycles<br>70 % UT (30 % dip in UT) for 25 cycles<br><5 % UT (>95 % dip in UT) for 5s | Mains power quality should be that of a typical commercial or hospital environment. If a dip or an interruption of mains power occurs, the current of the Vet25 may be dropped off from normal level, it may be necessary to use uninterruptible power supply or a battery. |
| Power frequency (50/60 Hz)<br>Magnetic field<br>IEC 61000-4-8  | 3 A/m   | 3 A/m   | Power frequency magnetic fields should be at levels characteristic of a typical location in a typical commercial or hospital environment.   |

*NOTE UT is the a.c. mains voltage prior to application of the test level*

In the event of an error, the device will auto-recover within 5 seconds.

Guidance and manufacturer's declaration – electromagnetic immunity

The Vet25 is intended for use in the electromagnetic environment specified below. The customer or user of the SunTech Vet25 should assure that it is used in such an environment.

| Immunity test                 | IEC 60601 test level            | Compliance level | Electromagnetic environment - guidance  |
|-------------------------------|---------------------------------|------------------|---|
| Conducted RF<br>IEC 61000-4-6 | 3 Vrms<br>150KHz<br>to<br>80MHz | 3 Vrms           | Portable and mobile RF communications equipment should be used no closer to any part of the Vet25, including cables, than the recommended separation distance calculated from the equation applicable to the frequency of the transmitter.<br><br>Recommended separation distance<br>$d = 1,2\sqrt{P}$<br>$d = 1,2\sqrt{P}$ 80 MHz to 800 MHz<br>$d = 2,3\sqrt{P}$ 800 MHz to 2,5 GHz<br>where P is the maximum output power rating of the transmitter in watts (W) according to the transmitter manufacture and d is the recommended separation distance in metres (m).<br>Field strengths from fixed RF transmitters, as determined by an electromagnetic site survey, should be less than the compliance level in each frequency range. Interference may occur in the vicinity of equipment marked with the following symbol:<br> |
| Radiated RF<br>IEC 61000-4-3  | 3 V/m<br>80MHz<br>to<br>2.5GHz  | 3 V/m            |   |



*NOTE 1 At 80 MHz and 800 MHz, the higher frequency range applies.*

*NOTE 2 These guidelines may not apply in all situations. Electromagnetic propagation is affected by absorption and reflection from structures, objects and people.*

a Field strengths from fixed transmitters, such as base stations for radio (cellular/cordless) telephones and land mobile radios, amateur radio, AM and FM radio broadcast and TV broadcast cannot be predicted theoretically with accuracy. To assess the electromagnetic environment due to fixed RF transmitters, an electromagnetic site survey should be considered. If the measured field strength in the location in which the Vet25 is used exceeds the applicable RF compliance level above, the Vet25 should be observed to verify normal operation. If abnormal performance is observed, additional measures may be necessary, such as re-orienting or relocating the Vet25.

b Over the frequency range 150 kHz to 80 MHz, field strengths should be less than 3 V/m.

Recommended separation distances between portable and mobile RF communications equipment and the Vet25

The Vet25 is intended for use in an electromagnetic environment in which radiated RF disturbances are controlled. The customer or the user of the Vet25 can help prevent electromagnetic interference by maintaining a minimum distance between portable and mobile RF communications equipment (transmitters) and Vet25 as recommended below, according to the maximum output power of the communications equipment. Wireless communications equipment such as wireless home network devices, mobile phones, cordless telephones and their base stations, walkie-talkies can affect this equipment and should be kept at least a distance d away from the equipment.

| Rated maximum output power of transmitter W | Separation distance according to frequency of transmitter m                            |  |   |
|---|--|--|---|
|   | 150 kHz to 80 MHz<br>$d = \left[ \frac{3,5}{V1} \right] \sqrt{P}$<br>$d = 1,2\sqrt{P}$ | 80 MHz to 800 MHz<br>$d = \left[ \frac{3,5}{V1} \right] \sqrt{P}$<br>$d = 1,2\sqrt{P}$ | 800 MHz to 2,5 GHz<br>$d = \left[ \frac{7}{E1} \right] \sqrt{P}$<br>$d = 2,3\sqrt{P}$ |
| 0.01  | 0,12   | 0,12   | 0,23  |
| 0.1   | 0,38   | 0,38   | 0,73  |
| 1   | 1,2  | 1,2  | 2,3   |
| 10  | 3,8  | 3,8  | 7,3   |
| 100   | 12   | 12   | 23  |

For transmitters rated at a maximum output power not listed above, the recommended separation distance d in metres (m) can be estimated using the equation applicable to the frequency of the transmitter, where P is the maximum output power rating of the transmitter in watts (W) according to the transmitter manufacturer.

*NOTE 1 At 80 MHz and 800 MHz, the separation distance for the higher frequency range applies.*

*NOTE 2 These guidelines may not apply in all situations. Electromagnetic propagation is affected by absorption and reflection from structures, objects and people.*



## Appendix A: Service Screens



**WARNING:** Do not disassemble the unit. There are no user serviceable parts except for the battery. Refer to qualified service personnel.

**WARNING:** The USB port is only a service port and cannot be used to download data or interface with the monitor. When updating the software, the monitor cannot be in use and the accessories should not be contacting the patient.



**CAUTION:** DO NOT remove unit covers. Doing so may increase the risk of electrical shock. This monitor does not contain any user serviceable parts. Substitution of a component or accessory different from that supplied may result in measurement error. Repairs should be undertaken only by personnel trained or authorized by SunTech Medical.

The SunTech Vet25 BP monitor includes a service mode where service information can be accessed, factory default settings can be restored and hardware verification checks can be performed. The service screens are accessed by holding down the power button for approximately 6 seconds when turning the monitor ON. When viewing service screens, the Start/Stop button LED is white.

No parts on the monitor or its accessories are serviceable.

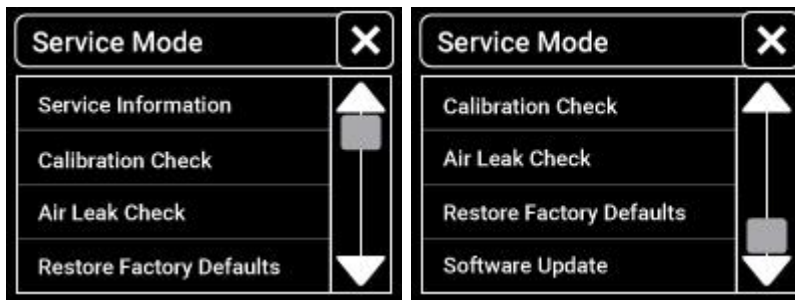

## Service Information

Basic details are logged which includes the number of measurement cycles, user interface firmware version, both firmware versions for the BP algorithm as well as a count for each status message. Status codes are provided to assist in troubleshooting during a service call. The image below is provided for example only.

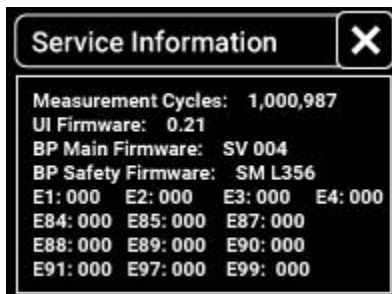

## Calibration Check

The pressure transducer in the SunTech Vet25 BP monitor is designed to hold its calibration for many years. Human NIBP devices require that the maximum static pressure accuracy shall be  $\pm 3\text{mmHg}$  or 2% of the reading, whichever is greater. This is a stringent requirement and all test equipment must be in excellent working order to properly perform this test. If you do not have access to this equipment or prefer to have someone else verify the calibration, the monitor can be sent to SunTech following the procedure described in the Limited Warranty section of this manual. There may be a charge associated with the verification if the transducer is not out of calibration.

SunTech suggests this check be performed every 2 years or if there is suspicion that the monitor may be out of calibration.



### Equipment Needed

Calibrated Manometer

Pneumatic "T" Adapters

Volume (500mL bottle or #6 or #7 cuff wrapped tightly around a solid object)

Hand Bulb

Connection Tubing

### Procedure

Connect a manometer, volume and the hand bulb to the end of the monitor hose using "T" adapters and connection tubing.

Touch the Start button which closes the valves and shows the pneumatic pressure.

Apply various pressures (between 0 mmHg and 250 mmHg) to the monitor with the hand bulb. INFLATE SLOWLY when adding pressure over 200 mmHg to avoid an overpressure. Verify that the module pressure is equal to the manometer pressure ( $\pm 3$  mmHg or 2% of the target value).

If the pressure is within limits, then touch the Stop button and the calibration check is complete.

If the pressure does not agree with the manometer, then the transducer needs to be re-calibrated. Send monitor back to SunTech Medical following the procedure in the Limited Warranty section of the manual.

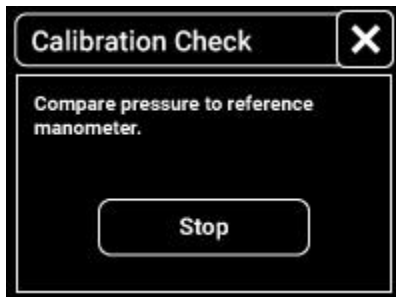

### Air Leak Check

International standards for human NIBP devices require that air leakage within the pneumatic system must not exceed 6 mmHg/min. During manufacturing at SunTech Medical, acceptable air leakage is less than 3 mmHg/min. Both of these pass criteria will not affect the performance or accuracy of the NIBP module so the SunTech Vet25 uses the 6 mmHg/min pass criteria. If you do not have access to this equipment or prefer to have someone else perform the air leak check, the monitor can be sent to SunTech following the procedure described in the Limited Warranty section of this manual. There may be a charge associated with performing an air leak check.

SunTech suggests this check be performed if there is suspicion of an air leak.



### Equipment Needed

Volume (500mL bottle or #6 or #7 cuff wrapped tightly around a solid object)

Standard patient hose

**TIP:** A reduction in cuff pressure is expected during the first 60 seconds due to pneumatic expansion of the cuff, patient hose and internal tubing. Make sure cuff is wrapped tightly around a solid object. Do not perform with cuff on a patient, lying flat or wrapped loosely.

### Procedure

Connect the volume to the monitor patient hose.

Touch the Start button which begins the air leak check and shows the pneumatic pressure and a timer. This check takes approximately 2 minutes.

When the check is complete, the monitor will indicate a pass or fail result.

If pass, then touch the Pass button and the air leak check is complete.

If fail, then there is an air leak within the pneumatic system. Try repeating the check with a different cuff making sure all connections are sealed. If it still fails, you may send the monitor and cuffs back to SunTech Medical following the procedure in the Limited Warranty section of the manual.



### Restore Factory Defaults

Factory defaults are restored by accessing this screen. A list of factory default settings is in the Technical Information section of this manual.



## Software Update

The software can be updated using a SunTech-provided USB drive.

### Procedure



**WARNING:** When updating the software, the monitor cannot be in use and the accessories should not be contacting the patient.

With the USB drive inserted into the device, touch Software Update from the Service Mode screen. A status bar will indicate the progress of the update. Do not turn off the device during the update. The device will restart when OK is pressed after the update is complete.

